

APD155

1 Output

19" DC/DC Converter, 170 W (200 W)

- ◆ DCin Wide Range 36...80 V DC
- ◆ Very high efficiency: typ. 93%
- ◆ Small: only 8 HP wide
- ◆ 20 % Power Boost for 1 hour
- ◆ Active decoupling (FET) for redundant operation (optional)
- ◆ Power fail, power good, shut-down (optional)
- ◆ Meets all relevant EMC standards



Data Sheet

The DC-DC converter APD155 with its 36...80 V wide range input is equally suitable for 48 V networks (the world-wide standard voltage for battery networks) and for 60 V networks (Deutsche Telekom) and can thus be implemented anywhere. The unit is **extremely efficient** (typ. 93%, where comparable units have 70...85% efficiency) and so presents much power in a small housing (170W need only 8 TE width).

An interesting feature is the **20% power reserve** (max. 200 W) which is available for an unusually long period of **60 minutes**.

Several **options** make the unit very flexible for different applications: for redundancy operation, an optional second output pin provides a **low-loss output decoupling** (FET). Furthermore, the unit is available on request also with **logical functions**: power fail/power good outputs signalize correct operation and a shut-down input allows remote switch-on and switch-off.

Vout	Iout	Pout	Features	Order-No.
23.5 V / 24.5 VDC	7.1 A	170 W	Standard version further versions on request	APD155.131

Front panel included and fitted: Append „F“ to order no. (e.g. APD155.131F)

Accessories H15 connector, 6.3mm flat contacts
H15 connector with soldering pins

Warranty 2 years from date of delivery

See the web for current data sheet version: www.puls-power.de

Output

Vout		23.5 V / 24.5 V DC	switchable via pin 16 or switch (see pages 2 + 4)
◦ tolerance	Vout	max. ± 1%	Includes production adjust., load and line regulation
Sense lines		—	
Minimum load		—	No minimum load necessary
Output power		max. 170 W	
◦ short-term		max. 200 W	for max. 1 h
Noise/Ripple		max. 20 mV _{pp}	20Hz...200kHz, I=I _{Nom}
◦ incl. spikes		max. 50 mV _{pp}	20Hz...20MHz, I=I _{Nom}
Over-voltage protect. (OVP)	typ.	28 V	Threshold accur. ±2 V
Derating		2 W/K	+60°C to +70°C T _{amb}
Operating indicator		1 green LED	On the front
Isolation Vout to Vin		SELV	EN60950, VDE0805, VDE0160

All outputs are protected against open-circuit, short-circuit, and overload

Schematic

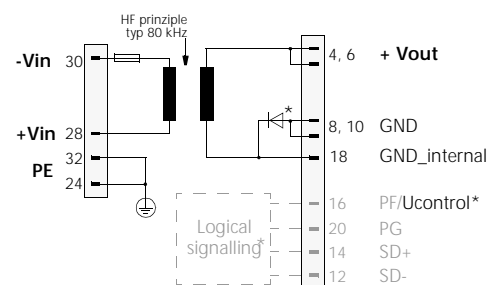

* see page 4

Mechanical	8 TE / 3HE board (DIN 41 494) Aluminium cover (AlMg3) for component side, plastic cover for bottom side LxWxH = 171,93 x 40,64 x 110 mm (100) Length incl. connector: see page 4
Weight	ca. 500 g
Connector	H15 connector (DIN 41 612) coding option load per pin: max. 11 A bei +70°C

Input

Line input DC		48/60 V DC	Wide range input
◦ Range		36...80 V DC	Full spec.
DC Input current	max.	6.5 A	@ 36 V DC
Noise suppression		EN 55 022/B	10kHz...30 MHz

Output (continued)	APD155	all versions
Voltage regulation:		
◦ Line regulation	max. %	± 0.5
◦ Load regulation stat. ΔU_{stat}	max. %	± 0.5
	max. %	± 1.0
◦ Load regulation dyn. ΔU_{dyn}	typ. ms	2
Response time t_s	typ. %/K	± 0.01
◦ Temperature coefficient	mV_{pp}	20
Ripple/Noise	mV_{pp}	50
◦ incl. Spikes		20Hz...200kHz, $I=I_{Nom}$
Current limitation	typ.	9...15 A
◦ Threshold	typ.	2.3 · I_{out}
◦ Current at short-circuit		approx. constant
◦ Characteristic	typ. ms	200
Start delay t_{Delay}		
On and off characteristic		-
Power-back immunity	max. μF	10,000
Choosing the output voltage at redundancy operation: switch unit A (permanent supply) to 24.5 V and protecting unit B to 23.5 V; thus unit B takes over the load only, if unit A fails. Voltage is selected by a switch at unit's upper side (see fig. on page 4), alternatively (on request) by pin 16 of the H15-connector.		

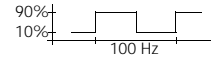

Input (continued)	APD155	all versions
DC input range	V_{DC}	36 ... 80
Inrush current	typ. A	140 A
Internal fuse		5x20 mm, T10A/250 V (IEC127/2)
Input voltage selection		-

Elektromagnetic Compatibility (EMC)

Emissions (EN 50081-1, includes also EN 50081-2)		
◦ Radio interference (EN 55011, EN 55022)	Class B Class A	Conducted 10kHz...30MHz Radiated 30MHz...1GHz;
Immunity (EN 50082-2, includes also EN 50082-1)		
◦ Electrostatic Discharge ESD, EN 61000-4-2	8kV direct discharge (Level 4) 15kV air discharge (Level 4)	
◦ Radiated fields, EN 61000-4-3	10V / m (Level 3)	DCin, Vout and signal lines: length = 1m
◦ Burst, EN 61000-4-4	2kV (Level 3) 2kV (Level 4) cap. coupling	Asym. and unsym. coupling to DCin/Vout line Coupled to Vout and signal lines
◦ Surge transients, EN 61000-4-5	1kV (Installation class 4) 1kV (Installation class 4)	Common mode: +Vin, -Vin to PE, unit on Differential mode: +Vin to -Vin, unit on
◦ Conducted disturbances, EN 61000-4-6	10V (Level 3)	Input-, output lines, 150 kHz...80MHz

Hold-up time

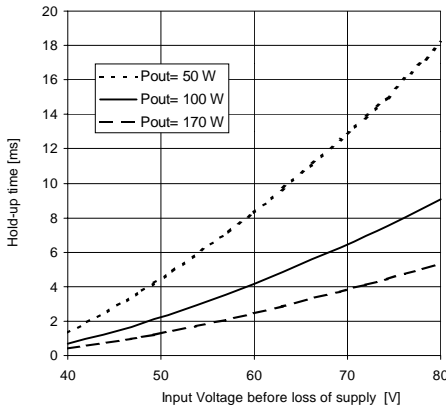

Typ. Output Characteristic

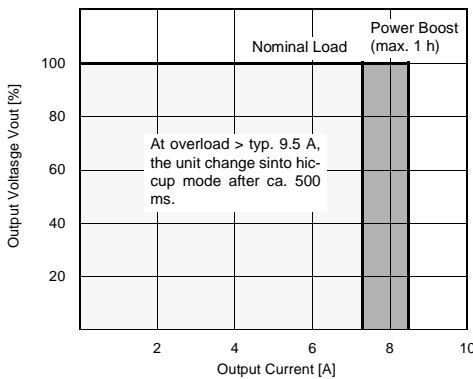

Typ. Derating over Temperature

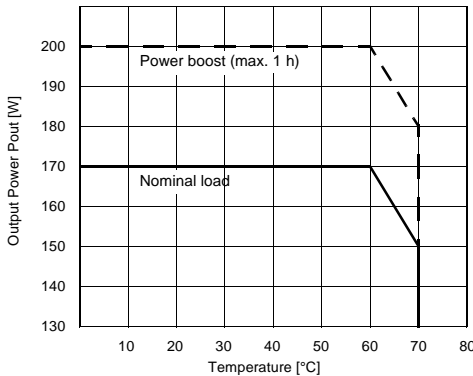

Typ. Efficiency

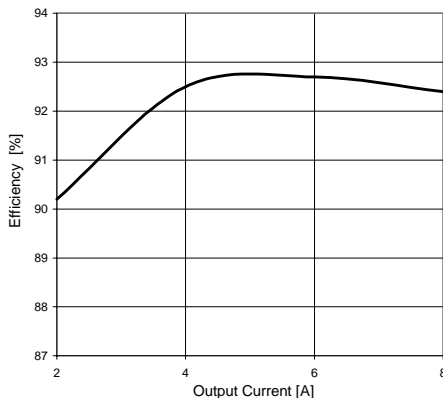

Protection and Monitoring

Unit protection

◦ Overload	yes	Hiccup ¹
◦ Short-circuit proof	yes	
◦ Open-circuit proof	yes	
◦ Over-temperature (OTP)	typ. no	
◦ Vin DC reverse battery prot.	yes	
◦ Prot. from over-discharging	yes	GND at Pin 8
◦ DCin Autoselect	—	DCin Wide Range

Load protection

◦ Over-voltage prot. (OVP)	yes
– Threshold	28V ± 2 V

¹ Hiccup = switch-off and cyclic restart attempts

Safety

Electrical Safety

◦ Test voltage acc. to EN 60 950 for t = 2sec	2kV AC 1.5 kV 500V AC	Primary / secondary, each unit Primary / PE Secondary / PE
◦ Air- and leakage distance	4 mm 3 mm	Primary / secondary Primary / PE
◦ Isolation resistance	min. 5 MΩ	VDE 0551
◦ Protection class	I	VDE 0106 part 1, IEC 536
◦ PE resistance	< 60 mΩ	VDE 0805
◦ Protection system	IP20	DIN 40 050, IEC 529
◦ Safe low voltage	SELV	EN 60 950, VDE 0805, VDE 0160
◦ Over-voltage class	I and II	VDE 0110 part 1, IEC 664
Touch safety	Finger test	VDE 0100 §6, EN 60 950, VBG4
Penetration protection	> 3mm	e.g. screws, small parts etc.

CE label

CE certification according to low-voltage directive and EMC directive

Operation and Ambient Area

Application class	KSF	DIN 40 040
Operation temperature	max. 0° to +70°C	T _{amb} (measured at 1cm distance)
◦ Derating range	+60° to +70°C	Derating 2 W/K (see fig. left)
Storage temperature	typ. -20° to +80°C	T _{amb}
Humidity	max. 95%	non-condensing
Mechanical usage	Vertical	see page 4
◦ Lateral distance	not necessary	cover side, full load
Cooling	Normal convection	Do not obstruct air flow!
Dirt protection level	max. 2	VDE 0100 part 1
Vibration	0.075mm	IEC 68-2-6 (10-60Hz)
Shock	11 ms / 15g	IEC 68-2-27 (3 shocks)
Operation height	max. 2000m	above sea level, derating beyond

Efficiency and Power Loss

Efficiency	typ. 93%	at 48 V DCin, I _{out} =100%
Power loss	typ. 12.8 W	at 48 V DCin, I _{out} =100%
	typ. 15.1 W	at 48 V DCin, 200 W load (< 1 h)

Reliability and Lifetime

MTBF (Siemensnorm SN29500)	200,000 h	48 V DCin, I _{nom} , T _{amb} =+40°C
Electrolytic capacitors	Only longlife types are used (>2.000h/105°C)	
Function test	100% each unit	
In-Circuit test	yes	
Run-in (Burn-in)	24h	I _{nom} , T _{amb} =+60°C, on/off-cycl.
Life-time class (telecomms)	B, 8 years	later on ripple may rise due to capacitance reduction

APD155 1 Output ♦ 19" DC/DC Converter ♦ 170 W (200 W)

Fuse

The unit has electrical protection against external short-circuits. In case of an internal defect, a fuse disconnects the unit. For safety reasons, the unit must be checked by the manufacturer then; therefore the fuse is not accessible for the user.

Installation for Operating

The unit is constructed for 19" systems: Ensure, that pin 4 of H15-connectors is on top, and insert unit to a corresponding slot. For other installation consideration consult your representative. **Ensure free air flow!**

Dimensions and Connections

19" board with touch-safe aluminium cover on the component side and plastic cover on the bottom side. 8HP plug-in width, other dimensions see figure and page 1 (subject to change)

Caution:

Do not remove any screws on box, as internal safety connections could be disconnected (consult your representative for details).

Schematic

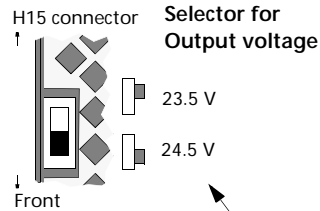
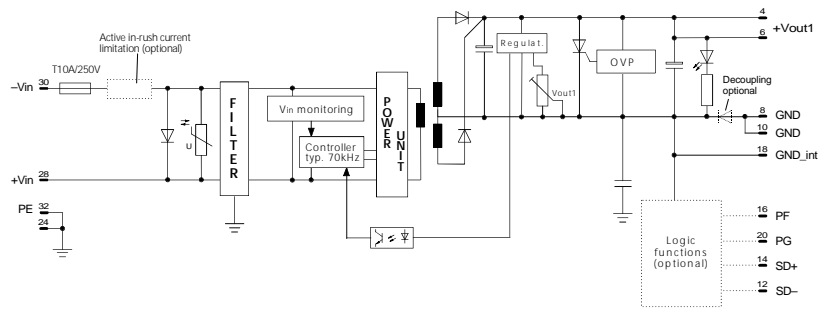

H15 Connection Scheme

NC= not connectable
(Do not connect!)

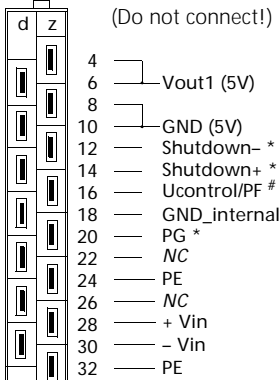

* only at versions with the according features, otherwise: NC
PF at versions with logic functions, otherwise Ucontrol

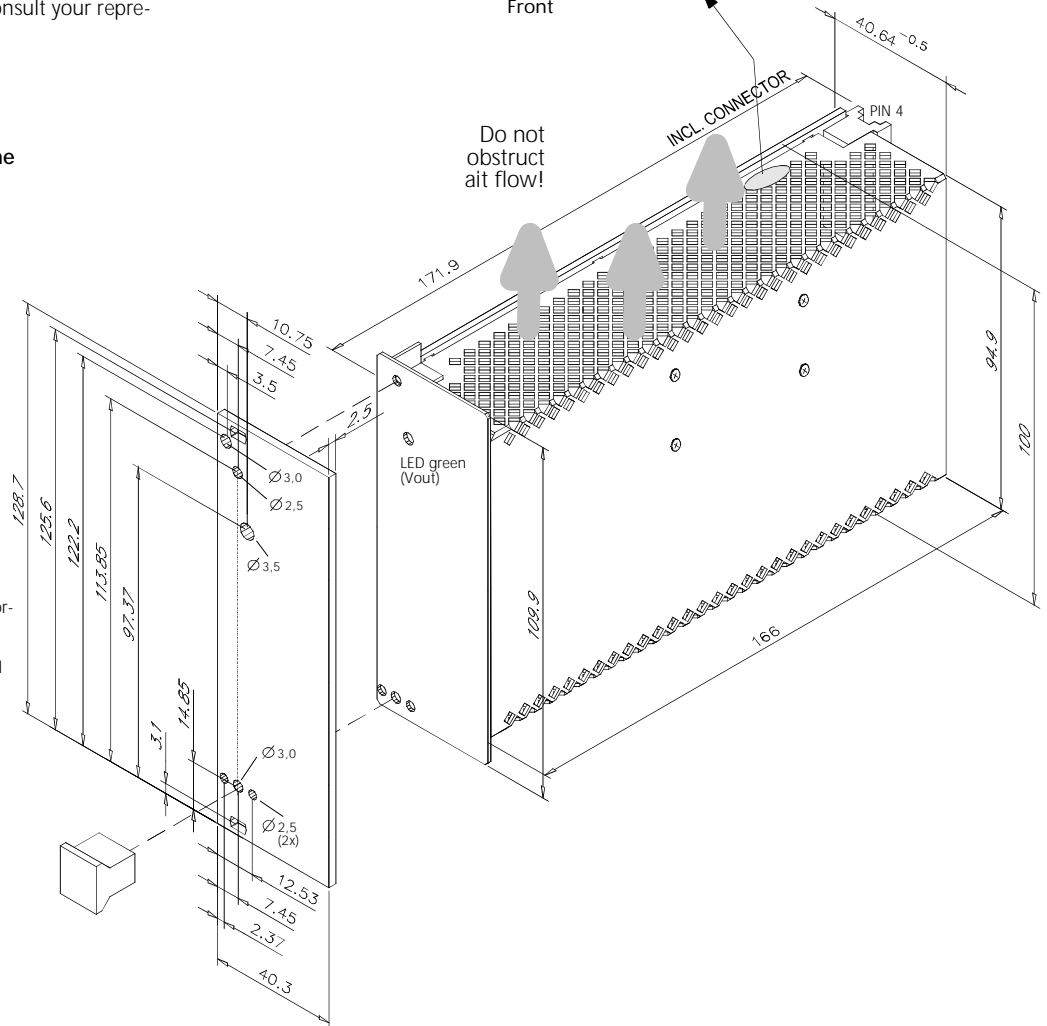

Modifikationen (on request)

Logic functions, input decoupling
Lower cost versions

Accessory ZP510

Installation set for mounting on DIN rail